



CARLISLE
SUNWELD
CONVENTIONAL SKYLIGHT

THE QUALITY STANDARD IN COMMERCIAL DAYLIGHTING

QUALITY • DURABILITY • PERFORMANCE

CARLISLE
SYNTEC SYSTEMS

CARLISLE SUNWELD

CONVENTIONAL SKYLIGHT

SunWeld™ Aluminum-Welded Skylights

SunWeld Aluminum-Welded Skylights offer the versatility and dependability required of the Carlisle brand and represent the quality standard for conventional industrial daylighting. These skylights reap the energy-saving benefits derived from natural daylighting, while offering a full custom-sized program with a broad spectrum of glazing options. Standard features offered include:

- Heliarc welded 6063-T5 extruded heavy wall aluminum frames
- Many non-thermoplastic glazing options including LOW-E insulated glass
- Several venting options
- Weep holes and polyurethane thermal break provided as specified
- Several fall protection options
- Welded aluminum insulated curbs - 9" or 12" standard
- Welded galvanized steel curbs both structural and non-structural



Curb Mount

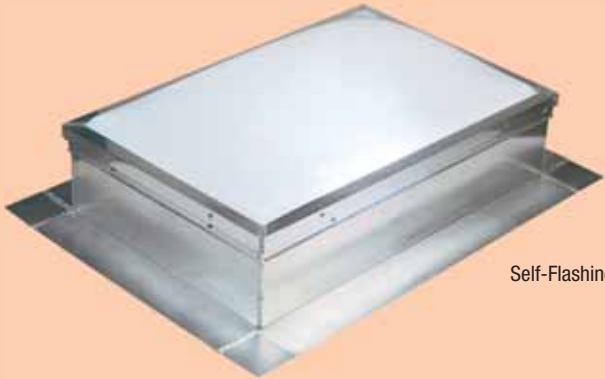

Self-Flashing



Optional Pyramid Dome available
on all acrylic and polycarbonate models

Curb Mount (CM)

Manufactured to fit onto an existing curb, curb mount units are used to replace existing skylight hatches that are defective or in a state of glazing failure. Curb mount units can also be specified when the contractor prefers to field-fabricate his own curb, flash it into the roofing system, and then install a curb mount skylight onto it.

Self-Flashing Skylights (SF)

These units are factory assembled onto a fully welded curb that is insulated with 1" rigid insulation, and can be manufactured fixed or with several venting options. The 3" mounting flange allows for easy fastening to the deck.

Other Models and Options Available:

Ridge lights, tandems, barrel vaults and tandems, among other items, are also available, along with additional glazing options, shapes and finishes. Call Carlisle Customer Service for a quote.

SUNWELD ALUMINUM-WELDED SKYLIGHTS

SunWeld Skylight Specifications

Curb Mount – Model CM

Curb-mounted acrylic-domed skylights must be Carlisle Model CM and be the specified shape. Factory-assembled units will consist of one or two thermoplastic domes held in place by a 6063-T5 extruded aluminum retaining angle and resting on an extruded aluminum inner frame. The assembly must have an integral condensate gutter with weep holes and optional polyurethane thermal break available as specified.

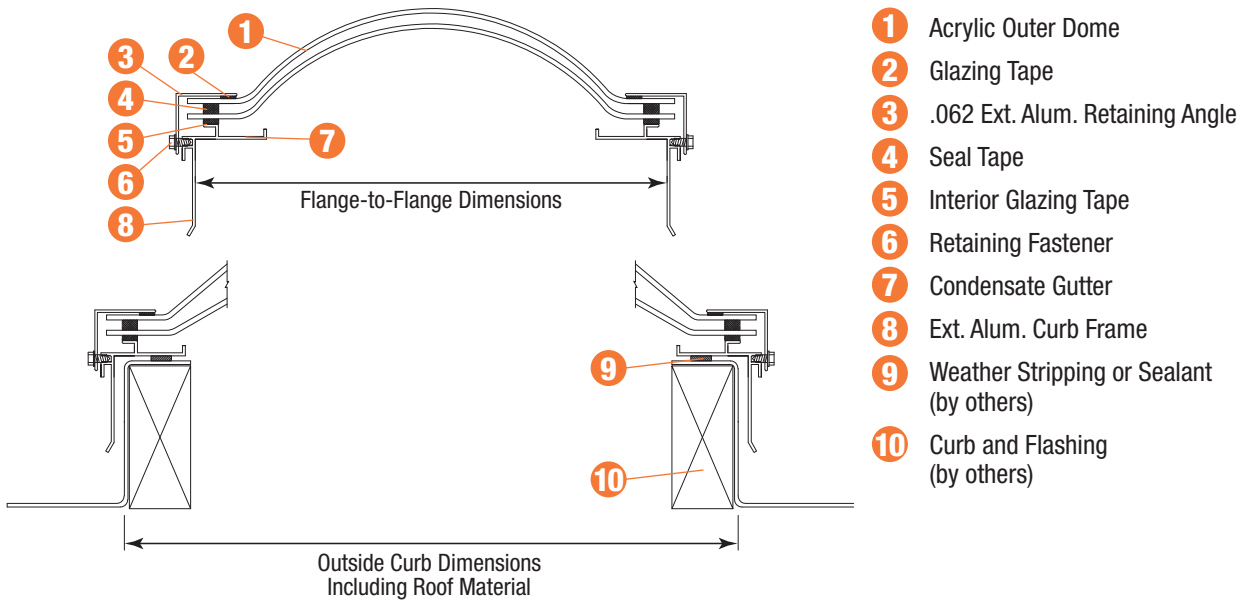

- 1 Acrylic Outer Dome
- 2 Glazing Tape
- 3 .062 Ext. Alum. Retaining Angle
- 4 Seal Tape
- 5 Interior Glazing Tape
- 6 Retaining Fastener
- 7 Condensate Gutter
- 8 Ext. Alum. Curb Frame
- 9 Weather Stripping or Sealant (by others)
- 10 Curb and Flashing (by others)

Self-Flashing Skylights – Model SF

Self-flashing acrylic-domed skylight must be Carlisle Models SF and have same specifications as the Curb Mount model with units factory-mounted onto a fully welded dual-wall insulated curb. Curb height must be 9" (standard) or 12" as specified and contain 1"-thick rigid foam insulation. These units have a 3"-wide mounting flange around the perimeter of the curb.

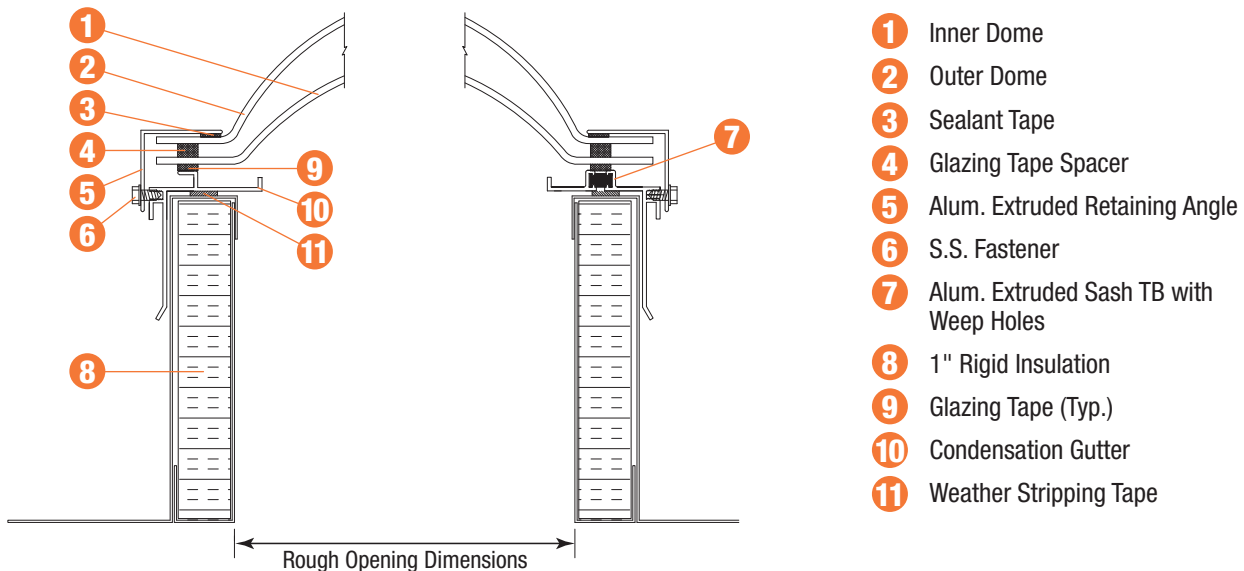

- 1 Inner Dome
- 2 Outer Dome
- 3 Sealant Tape
- 4 Glazing Tape Spacer
- 5 Alum. Extruded Retaining Angle
- 6 S.S. Fastener
- 7 Alum. Extruded Sash TB with Weep Holes
- 8 1" Rigid Insulation
- 9 Glazing Tape (Typ.)
- 10 Condensation Gutter
- 11 Weather Stripping Tape

SunWeld Vaulted Prismatic Skylight

These skylights with their unique dome configuration provide superior impact strength and light collection properties and can respond to specifier requests for prismatic glazing. Compared to similar competitors' models, these units are also manufactured with a true thermal break (pour and de-bridge) and gentler dome provide to eliminate shadowing and increase light transmissions.



The center cavity of the aluminum frame is filled with a 50-year life, non-thermal conductive resin and cured. The 2" horizontal frame flange is then milled out to the level of the epoxy. This process achieves a complete and total separation of the exterior aluminum frame and the aluminum frame in the interior of the building.

Thermal Break Comparison

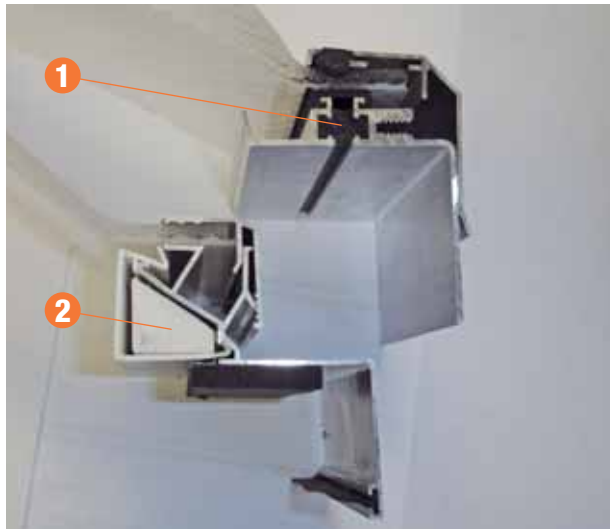

- 1 SunWeld PU Bridge (does not allow conduction)
- 2 EPS Block (Competitor) – Not a true thermal break

Light Transmission Comparison



Competitor (shadowing effect)



SunWeld Prismatic (17% more light transmission)

Dome Comparison

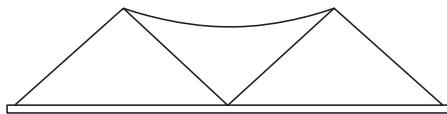

SunWeld Prismatic

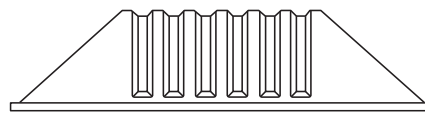

Competitor

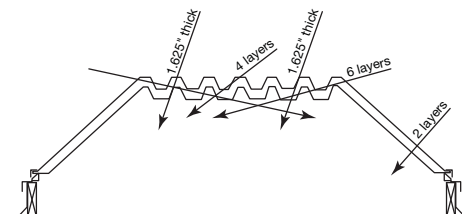
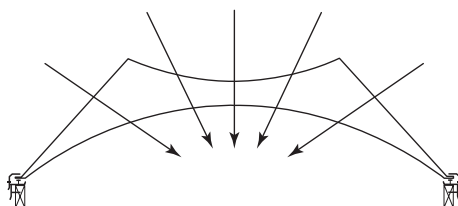

Above diagrams demonstrate how sunlight at low angles must pass through more layers of plastic with the competitor's dome profile vs. the tri-arch SunWeld Prismatic. This causes their distinct "shadowing effect" and loss of visible light transmission.

SUNWELD ALUMINUM-WELDED SKYLIGHTS

Heat/Smoke Vents/Roof Hatches

Mechanical Type with Fusible Link

The SunWeld Mechanical Smoke Vent is activated by an electro-thermal fusible link with various load lifting capabilities. All units are ICC code compliant, with UL listed and FM approved smoke vents also available. Units are available with insulated metal lids, single or double dome glazing, with activation temperatures available from 165° up to 500°. Can be curb mount or self flashed. Door latches are fully adjustable after installation, ensuring proper wind uplift protection and proper tensioning of the vent.



Drop-Out Type with Safety Cage

The SunWeld Drop-Out Smoke Vent is glazed with a special heat sensing plastic that when activated, softens the glazing material and releases it from its retainer frame, venting smoke and gas. Units work with any sprinkler system including ESFR sprinklers. The vents operate within five minutes with exposure to fire. Both curb mount and self flashed units are available and they are delivered with a standard safety cage. An OSHA compliant cage is available as an upgrade. A UL listing is available.



Roof Access Hatch

The SunWeld Roof Access Hatch has a 12" curb with a 3.5" mounting flange with holes for roof attachment. The outside cover is made of 14 GA steel with radiused corners. Cover is insulated and reinforced as required to support a 40 lbs/ft² live load. All hardware is corrosion resistant and all fasteners provided are the self-locking type. This unit is available with a safety grab railing system (optional) that attaches to either corner of the exterior hatch opening. 17" high, and extending 10" from each corner, it is painted red for easy visibility. Available in 2 standard sizes, 30" x 36" and 36" x 36".



ORDERING INFORMATION

Typical Sizes

Square SunWeld Commercial Skylights		
Model Number	Self-Flashed (Inside Curb Opening)	Curb Mount (Outside Curb Opening)
1414	14 1/4" x 14 1/4"	17 1/4" x 17 1/4"
1919	19" x 19"	22" x 22"
2222	22 1/4" x 22 1/4"	25 1/4" x 25 1/4"
3030	30 1/4" x 30 1/4"	33 1/4" x 33 1/4"
3737	37" x 37"	40" x 40"
4242	42" x 42"	45" x 45"
4646	46 1/4" x 46 1/4"	49 1/4" x 49 1/4"
4848	48" x 48"	51" x 51"
5555	55" x 55"	58" x 58"
7070	70 1/4" x 70 1/4"	73 1/4" x 73 1/4"
7575	75" x 75"	78" x 78"
8484	84" x 84"	87" x 87"
9292	92 1/2" x 92 1/2"	95 1/2" x 95 1/2"
Rectangle SunWeld Commercial Skylights		
1422	14 1/4" x 22 1/4"	17 1/4" x 25 1/4"
1446	14 1/4" x 46 1/4"	17 1/4" x 49 1/4"
2230	22 1/4" x 30 1/4"	25 1/4" x 33 1/4"
2237	22 1/4" x 37"	25 1/4" x 40"
2246	22 1/4" x 46 1/4"	25 1/4" x 49 1/4"
2272	22 1/4" x 72"	25 1/4" x 75"
2296	22 1/4" x 96"	25 1/4" x 99"
3037	30 1/4" x 37"	33 1/4" x 40"
3046	30 1/4" x 46 1/4"	33 1/4" x 49 1/4"
3069	30 1/4" x 69 1/2"	33 1/4" x 72 1/2"
3096	30 1/4" x 96"	33 1/4" x 99"
3496	34" x 96"	37" x 99"
36120	36" x 120"	39" x 123"
3746	37" x 46 1/4"	40" x 49 1/4"
3775	37" x 75"	40" x 78"
3859	38" x 59"	41" x 62"
4669	46 1/4" x 69 1/2"	49 1/4" x 72 1/2"
4689	46 1/4" x 89 1/2"	49 1/4" x 92 1/2"
4896	48" x 96"	51" x 99"
48120	48" x 120"	51" x 123"
5460	54" x 60"	57" x 63"
SunWeld Vaulted Prismatic Skylights		
4848	48" x 48"	51" x 51"
4896	48" x 96"	51" x 99"
6072	60" x 72"	63" x 75"
Mechanical Smoke Vent with Fusible Link*		
4848	48" x 48"	51" x 51"
6060	60" x 60"	63" x 63"
4872	48" x 72"	51" x 75"
6072	60" x 72"	63" x 75"
4896	48" x 96"	51" x 99"
6096	60" x 96"	63" x 99"

Self-Flashed Units

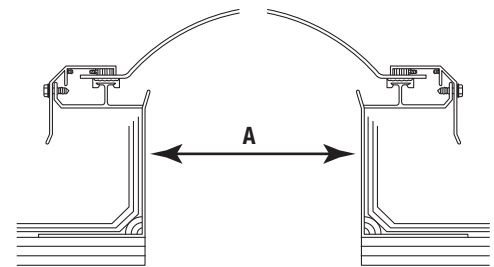

Size indicates roof opening dimensions or inside curb dimensions (A)

Curb Mount Units

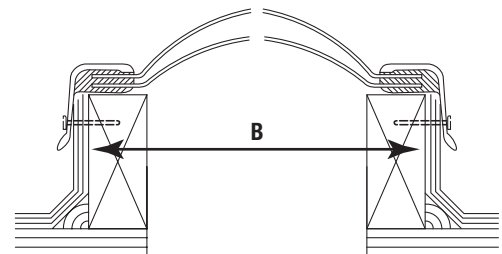

Size indicates outside curb dimensions (B)

*Drop-Out Type Smoke Vents also available

SUNWELD ALUMINUM-WELDED SKYLIGHTS

Prescriptive Acronyms for Model Identification

Model Characteristic	Acronym (Specify by adding to model description)
Curb Mount	CM
Self-Flushed	SF
Acrylic Glazing	A
Polycarbonate Glazing	PC
Double Dome	2
Pyramidal Domes	P
Thermally Broken	TB
Curb Height	9 or 12
Manual Operable	SD
Electric Operable	ESD
Venting	V
Venting Electric	VE
Mill Finish	MF
Anodized Finish	AN
Bronze Anodized Finish	BAN
Painted Frame	PF
White Painted Frame	WP

Acrylic Color Choices	Acronym (Specify by adding to model description)
High White Translucent	WTH
Medium White Translucent	WTM
Low White Translucent	WTL
Bronze	BT
Grey	GT
Clear Colorless	CC

Example:

CM-2-TB-MF-WTM/CC = A curb mount double dome unit, thermally broken with a mill finish frame. Glazing to be acrylic with a medium white over clear double dome assembly.

Glazing Information

Glazing Material	Light Transmittance*			Shading Coefficient*		
	Single	Double	Triple	Single	Double	Triple
High White (WTH)	82%	75%	69%	.76	.72	.68
Medium White (WTM)	53%	49%	45%	.68	.63	.58
Low White (WTL)	32%	29%	27%	.45	.40	.36
Bronze Tinted (BT)	27%	25%	23%	.53	.43	.35
Grey Tinted (GT)	27%	25%	23%	.50	.44	.36
Clear Colorless (CC)	95%	92%	85%	.97	.89	.82

	U-Values/R-Values* BTU/HR/Square Foot/°F		
	Single Dome	Double Dome	Triple Dome
Winter Heat Loss Heat Loss (15 mph wind)	1.2/0.83	0.7/1.43	0.4/2.5
Summer Heat Gain Heat Gain (7.5 mph wind)	0.8/1.25	0.5/2.0	0.3/3.33

Note: During extended periods of temperature and humidity differential condensation may form between double domes. However once this differential is reduced the condensation will dissipate.

*These values are approximate for flat sheets. They may vary with material thickness and final unit configurations.

Glass Options for Custom Skylights

Carlisle procures superior quality glass products from the major Architectural Glass Manufacturers nationwide. Because of the vast assortment and combinations of high performance coatings, colors and thickness it is not possible to list them all here. The following indicate a sampling of the most commonly used make-ups for overhead glazing and their associated properties. We would recommend consulting with your design professional in selecting the appropriate glass type for your application and contact Carlisle's Design and Review Department for further information.

Insulating Glass Type	Exterior Appearance	Aesthetic Effects	L-T %	Daylight Reflectance		Winter Nighttime U/R	Summer Daytime U/R	Shading Coefficient	UV** Transmittance
				Out %	In %				
Clear	Clear	Transparent	80	15	15	.49/2.04	.56/1.79	0.82	<1%
Bronze	Tinted	Light Brown	47	9	13	.49/2.04	.57/1.75	0.57	<1%
Grey	Tinted	Light Grey	37	8	13	.49/2.04	.57/1.75	0.55	<1%
Clear Low-E	Reflective	Transparent	76	13	12	.30/3.33	.32/3.13	0.67	<1%
Reflective (2) Bronze*	Reflective	Dark Brown	20	15	37	.49/2.04	.58/1.72	0.38	<1%
Translucent White	Milky	White	65	14	14	.49/2.04	.57/1.75	0.76	<1%

Note: 1. Clear Glass is transparent flat glass that meets the requirements and tolerances of federal specification DD-G-451 d.

2. All of the above glasses can be heat-strengthened or tempered to meet standard Z97.1 and the Consumer Product Safety Commission Standard 16 CFR 1201 C1 and C2.

*3. The appearance and aesthetic effect of reflective glass is greatly affected by the location of the coated side. "(2)" means the coating is on the inside surface (2) of the exterior lite.

**4. Based on laminated glass as the interior lite of the insulation unit. Cut off at 380 nanometers (nm) wavelength. Screening out ultra violet radiation can help protect materials. However, consult with your design professional on skylight placement and compatibility. There is no guarantee or warranty against fading.

Shading Coefficient: The dimensionless ratio of the total solar heat gain from a particular glazing system to that for one sheet of clear 3 mm (1/8") double-strength glass. The solar heat gain is the sum of the transmitted solar energy plus that portion of the absorbed solar energy which flows inward.

Carlisle's SunWeld Daylighting Systems

	Acrylic	Copolyester	Polycarbonate	Fiberlite Fiberglass	Prismatic	Silica Aerogel	Special Acrylic
Key Attribute	Lowest Cost	Greater Strength and impact resistance than Acrylic with similar cost	Best impact resistance, hurricane and burglar proof	Best strength, Leakproof	Best light transmission	Best insulator	Lowest Solar Heat Gain
VLT Light Transmission %	53%	60%	60%	63%	70%	50%	50%
SHGC Solar Heat Gain Coefficient	0.31	0.50	0.26	0.46	0.47	0.31	0.26
U Factor/Insulating Value	0.71	0.65	0.71	0.63	0.73	0.37	0.45
Haze/Light Diffusion %	98%	98%	98%	100%	100%	100%	100%
Glazing Material Notes	Medium White Acrylic over Clear Acrylic	White Copolyester over Clear Acrylic	Clear Polycarbonate over White Polycarbonate	Fiberglass over Clear Acrylic	Clear Impact Modified Prismatic over White Impact Modified Prismatic	Clear Acrylic over Clear 16mm Polycarbonate panel filled with Silica Aerogel	Clear Coolite Impact Modified Acrylic over Clear MW Polycarbonate
Dome Design-Shape	Bubble	Triarch	Bubble	Bubble	Triarch	Bubble	Bubble
OSHA Load Test	Pass	Pass	Pass	Pass	Pass	Pass	Pass
Total Load Test	400 lbs	800 lbs	1,600 lbs	2,200 lbs	400 lbs	400 lbs	400 lbs
Hail Resistant	Limited	Moderate	Passed FM 2" Severe Hail Test	Passed FM 2" Severe Hail Test	Limited	Limited	Limited
Rate of Burning UBC-26-7/ASTM D635-06	CC2	CC1	CC1	CC1	CC2	CC2	CC2
Smoke Density ASTM D2843-99	Pass	Pass	Pass	Pass	Pass	Pass	Pass
Ignition Temperature (Self Ignition) ASTM D1926-96	Pass	Pass	Pass	Pass	Pass	Pass	Pass
Warranty	10 years No-Leak	10 years No-Leak	10 years No-Leak	10 years No-Leak & <1% VLT Loss Per Year	10 years No-Leak & Maximum VLT Loss 3%	10 years No-Leak	10 years No-Leak

All skylights above are available with either zinc plated steel or architectural grade 6063-T6 aluminum frames. Frame types include curb mount, self flashing (curb mount with an integral curb), or curb mount with a separate structural curb. All frames are designed with condensation gutters and non-clog weep holes. Frame options include AAMA compliant thermal break, 1" polyboard insulation, wood nailer, louvers, rain guards and custom outside/inside curb, curb height and flange dimensions.

Performance information obtained through NFRC, NAFS, ICC, AAMA, UL, FM AND ASTM standards and testing. Load test results are for specific outer dome thicknesses.

For additional technical information and/or daylighting systems design consultation, please contact Carlisle for your specific needs.