

3 UNDER PLATE - TYP. FASCIA

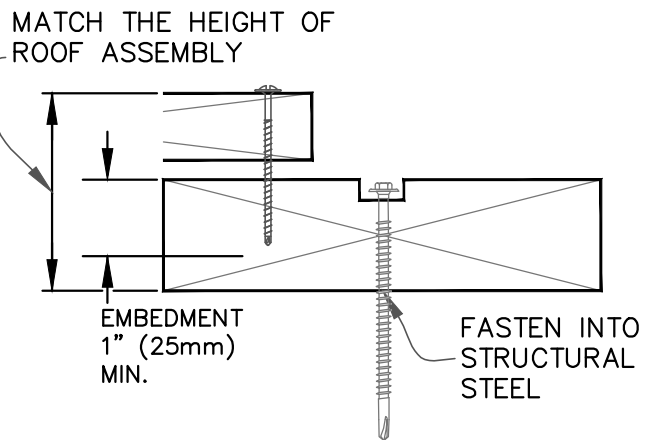

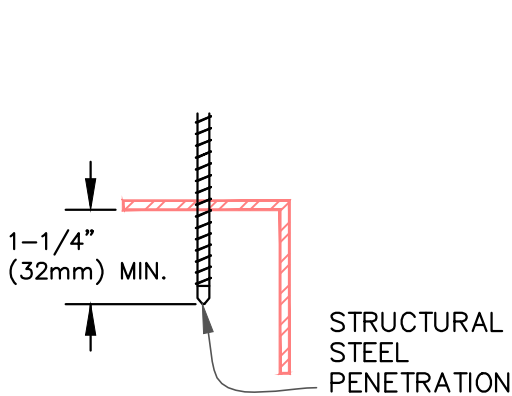

4 UNDER PLATE: C-CHANNEL



5 FASTENER INTO STRUCTURAL STEEL

6 FASTENER INTO WOOD

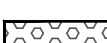
ENLARGED DETAILS

	• HIGH DENSITY RECOVER BOARD		• ROOF MEMBRANE
	• IN-FILL INSULATION		• WOOD NAILER (BY OTHERS)
			• SEE DRAWING NOTE(S)

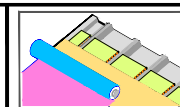

SHEET NO.
MR | Z1.1